



2°C-8°C MEDICAL REFRIGERATOR

REF13-60



INDEX

1. Preface	2
<hr/>	
2. Safety Instruction	3
<hr/>	
2.1 Prohibition	3
2.2 Warning	5
2.3 Cautions	6
3. Installation Instruction	7
<hr/>	
3.1 Installation Location	7
3.2 Installation Steps	8
3.3 Application	9
4. Operation Instruction	9
<hr/>	
4.1 Structure	9
4.2 Temperature Controller	10
4.3 Adjust Setting Temperature	11
4.4 Check Highest and Lowest Temperature	11
4.5 Set Date and Time	12
4.6 Alarm	13
4.7 Battery Switch	14
5. Maintenance	15
<hr/>	
5.1 Before Maintenance	15
5.2 Clean	16
5.3 Defrost	16
5.4 Battery Maintenance	16
6. Troubleshooting	17
<hr/>	
7. Circuit Diagram	18
<hr/>	
8. Packing List	19
<hr/>	

1. Preface

Thank you for choosing and using our equipment. Please read this manual carefully before using the device and keep it properly for future reference.

This manual contains important safety advice. Ignoring the following <Safety Instruction> may cause damage to the equipment and/or user injury.

The user is responsible for any damages to the device caused by ignoring the requirements of this manual during use.

The user is responsible for any personal injuries caused by ignoring the requirements of this manual during use.

If the functions and appearance of the device are updated, the new device is inconsistent with the device listed in this manual, please refer to the actual product.

Service life of the device: 8 years

Please contact us or our authorized distributors if any points in this manual are unclear or if there are any inaccuracies.

Meaning of Symbols:

☐ Prohibition: This symbol means an action is prohibited. Ignoring this sign may cause personal injury and may result in serious injury or death.

⚠ Warning: This symbol means risk warnings. Ignoring this sign may cause damage to the equipment and/or personal injury.

⚡ Cautions: This symbol is used for operation reminders. Special attention is required when using the device.

Warning Labels:







	Be careful not to pinch your hands.
	Be careful to prevent electric shock.
	Be careful to keep the device away from fire.
	Watch your fingers to avoid being hurt by the fan.
	Sensor box: sensor inside.
	Max loading line: Do not put items over this line.
	Min loading line: Do not put items lower than this line.

Table 1

NOTE: Not all devices have the above labels, please refer to the actual product.

2. Safety Instruction

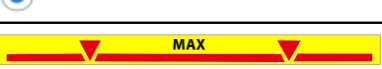
2.1 Prohibition

- Only authorized technicians are allowed to install, move, disassemble, and repair this device. Do not do these by yourself. Unauthorized personnel's improper operation may cause electric leakage, shock, personal injury, or fire.
- Do not install the device outdoors or in damp or splashing water areas. Exposure to rain and moisture will cause rust and reduce its electrical insulation properties, which may cause electric leakage, shock, and fire. If installation in a damp area is unavoidable, please use an electric leakage breaker to avoid electric shock.
- Do not install the device in a place with acidic or corrosive gases or liquid, otherwise, the device may be corroded and cause electric leakage or shock.
- Do not install the device in a location with flammable or volatile substances. Do not use any flammable or volatile substances around the device. This may cause explosions and fires.
- Install the device on a solid, level floor that can hold the weight of the device. Adjust the adjustable feet or castors on the bottom of the unit until they are firmly in contact with the floor (only available for the device with adjustable feet or castors). If the floor is unstable or uneven, or the device is not installed properly, it may cause unusual noise and vibration. In severe cases, device tipping or falling may cause serious personal injury.
- If the device has a CO₂/LN₂ backup system, make sure the device is installed in a well-ventilated room. Otherwise, the room may be severely starved of oxygen due to CO₂/LN₂ leaks.
- Connect the device to the power source indicated on the nameplate. Using other power sources may cause device failure, electric shock, or fire.
- Please connect the device to a dedicated power socket with a ground wire. Do not connect the ground wire of the socket directly to the ground, lightning rods, telephone wires, gas pipes, water pipes, and other objects, to prevent electric shock, fire, or explosion caused by poor grounding. Do not connect the device to extension cords or an electrical outlet divider as this may cause a fire due to overheating of the electric circuit.
- Please remove dust from the plug before connecting it. Dusty plugs may cause electrical leakage or fire. During daily use, please clean the plug regularly.
- Make sure the plug is fully inserted into the socket. Poor connections may cause electric shock or fire.
- Do not cut, shorten, scratch, convert, bend, pull, or tie the power cord. And do not put any heavy objects on it. Make sure the cord is not being pinched. Any damage to the power cord may cause fire or electric shocks.
- Pull on the plug, not the power cord when unplugging the device. Or it may cause overheating and fire due to the internal damage of the power cord.
- Use the switch to turn the device on and off, not the plug. Plugging or unplugging the device while it works may cause a short circuit or electric shock.
- Do not touch any electrical parts such as plugs or switches with wet hands, as this may cause electric shock.
- Do not pour water onto the device or clean the device with water directly, otherwise, it may cause electric shock or fire.
- Do not put heavy objects or containers with liquid on the device. If the object falls, it may cause serious personal injury. And the spilled liquid will cause rust and reduce the electrical insulation properties of the

device. In severe cases, it may cause electric leakage, shock, and fire.

- Do not climb on this device, if the device tips over, it may cause serious personal injury or damage to the device.
- Do not hang on the door. If the door comes off or the device tips over, it may cause serious personal injury or damage to the device.
- Do not store acidic or corrosive substances in this device. This may cause internal components or electrical parts of the device to be corroded and damaged, and cause electric leakage or fire.
- Do not store any form of volatile, flammable, or explosive substances (such as ether, benzene, propane, or glue) in this device, since they may cause explosions and fire.
- Do not store any objects or containers with liquid in this device (unsealed). If they tip over inside the device, the spilled liquid may cause electric shock or fire.
- When storing hazardous or radioactive materials, use this device in a safe area. Improper use may cause serious environmental pollution and personal injury.
- Do not put your fingers or other objects into vents or air intakes, it may cause device failure, electric shock, or personal injury, because there is a high-speed rotating fan inside.
- Do not use knives or sharp tools to defrost the device. There are cooling pipes behind the inner wall of the device. If the inner pipes or electric wires are damaged, it may cause a breakdown or personal injury. Also, do not make holes in the device to install other accessories.
- Do not touch the condenser directly when the filter net is removed for cleaning. This may cause injury by the hot surface (Only available for the device with filters).
- Turn off and disconnect the power supply plug if there is something wrong with the device. Continued abnormal operation may cause electric shock or fire.
- Turn off and disconnect the power supply plug before moving the device. Take care not to damage the power cord. A damaged cord may cause electric shock or fire.
- Turn off and disconnect the power supply plug before repairing or maintaining the device to prevent electric shock or injuries.
- Do not touch the device when refrigerant leaks, and turn off the pipeline valves of flammable gas in the room promptly (If there are gas valves).
- Unplug the power cord when stop using the device for a long time. In case the aging of the power cord leads to electric shock, leakage, or fire.
- Do not put plastic packages where are accessible to children, or it may cause suffocation.
- Children are not allowed to have access to this equipment. If the device is installed in an unattended area or is unused for an extended period, make sure the device is not accessible to children to prevent possible electric shock or suffocation from being accidentally locked inside the device.
- It's better to exchange the device if its service is reached, aging of electrical components and circuits may cause a breakdown, electric shock, or fire. If you still insist on using this equipment, please increase the frequency of inspection and maintenance to prevent accidents.
- The disposal of the device should be accomplished by appropriate personnel. Always remove doors to prevent accidents such as suffocation.

2.2 Warning

- ⚠ Only authorized and trained operators are allowed to use this device.
- ⚠ If the operator encounters a situation not mentioned in this manual, do not handle it by yourself, otherwise it may cause a breakdown. Please contact us or our authorized distributors to inquire about the correct handling method.
- ⚠ Please use the accessories provided by us, otherwise, it may cause a breakdown. If using other accessories is unavoidable, contact us to confirm whether the accessories meet the requirements.
- ⚠ Do not place glass bottles or jars in this device, as they may break due to freezing, and cause personal injury (only for deep freezers).
- ⚠ Wear protective gloves when removing frozen items from the device. Touching frozen items or the inside walls with bare or wet hands may cause frostbite.
- ⚠ During daily use, please ensure that there are no foreign objects in the door seal, otherwise, it will cause severe frost or ice on the device and reduce the refrigeration performance.
- ⚠ Always hold the handle when closing the door to prevent your fingers from being pinched.
- ⚠ At least 2 staff working together is necessary when moving the device. Before moving, unlock the castors or adjustable feet (if the device has them) and be careful not to tip over the device during movement to prevent damage or injury.
- ⚠ Do not turn on the power for 1 hour after moving, which may cause a breakdown.
- ⚠ Inspect and maintain the device at specified intervals.
- ⚠ Wear gloves when maintaining or repairing this device to avoid injury from sharp edges.
- ⚠ Be careful not to inhale medications or suspended matter in or around the device when maintaining or repairing this device. These may be harmful to your health.
- ⚠ Clean the filter or condenser of the device every 6 to 12 months (depending on the room's cleanliness. If there is a lot of dust, the filter or condenser will be blocked, and cause poor refrigeration performance or a breakdown.
- ⚠ Do not clean the device with scrubbing brushes, acid, thinner, solvents powdered soap, cleanser, or hot water. These agents can scratch the paint or cause it to peel. Plastic and rubber parts can be easily damaged by these materials, especially solvents. When a neutral detergent is used to clean the device, wipe off the neutral detergent with a wet cloth.
- ⚠ Do not change the factory setting parameters of the device, or it may cause a breakdown and damage to the device.
- ⚠ Check the settings before restarting the device after maintaining, repairing, power outage, or shutting off the power to prevent the loss of preset parameters. Changes to settings may damage stored items.

2.3 Cautions

- ✂ This device is not a quick-freezing equipment and cannot be used to quick-freeze items. This device is only used for long-term storage of temperature-sensitive materials or items.
- ✂ This device cannot improve the status or activity of stored items.
- ✂ The device does not have therapeutic functions and cannot be used for treatment.
- ✂ This device is non-sterile and non-sealed. Do not store radiation, toxic, radioactive, or infectious items that are not isolated and sealed.
- ✂ The device does not discharge liquids, chemicals, or waste.
- ✂ Install the device in an area with low temperature and humidity. If the device is placed in direct sunlight or near a heat source, it may cause poor refrigeration performance.
- ✂ Leave enough space between the device and the wall. Do not block the air intake and outlet of the

device. Small spacing will affect its heat dissipation and cause poor refrigeration performance.

✂ If the surrounding temperature is outside the optimum range (10°C~32°C), it may cause a breakdown.

✂ This device has an alarm system. When the device breaks down, it will have audible and visual alarms. When first used, the alarm system will stop working for 3 to 8 hours (depending on the model number).

✂ When first used, the device may keep making loud noises and its surface may overheat. This is normal and will alleviate when the device reaches the set temperature.

✂ The temperature is not the same at different points inside the device. The displayed temperature on the controller is a calculated average temperature. If you use a temperature measuring instrument to test the inner temperature of the device, the measured value may be different from the value displayed on the device, this is normal.

✂ Do not put in items until the device has reached the set temperature and the inner temperature is stabilized. During daily use, do not put too many high-temperature items in the device at one time, otherwise, the inner temperature will rise significantly and cause an alarm. For ultra-low temperature freezers, please precool the items to -20 to -40°C before put in the device.

✂ Before storing anything, make sure the inside of the device is clean.

✂ Do not store items that are too wet, otherwise it may cause frost or ice inside the device, and cause bad or abnormal refrigeration performance.

✂ Do not store living creatures in this device.

✂ The device does not involve the storage period/life of stored items.

✂ The temperature inside the device will rise during a power outage or the device fails. If it cannot be repaired in time, please take out the stored items and transfer them to other normal working devices to avoid damaging the stored items.

✂ If the device does not have a remote alarm function, please ensure that the device is patrolled 24 hours a day. Otherwise, no one may notice when the device fails or has a power outage, and cause the stored items to deteriorate due to overheating.

✂ When using the device, please follow the requirements of this manual and the tips and warning labels on the device. Otherwise, it may cause danger or cause poor performance of the device.

✂ Please consult the relevant local government authorities if you need to discard the packaging materials or the spare parts of the device.

✂ To maintain the device on time and to quickly check the maintenance and repair records of the device when it fails, please prepare a maintenance and repair record form for this device.

3. Installation Instruction

3.1 Installation Location

This product is designed at 25°C ambient temperature, a relative humidity of 80%, and is only able to work in a specified environment, or it will affect the refrigeration performance, even causing a breakdown. Exceeding this state may cause damage to the refrigeration system.

Recommend Installation Locations:

- Ambient temperature: 10 to 32°C

- Relative humidity: Below 80%

- Enough space: Leave at least 30cm between the device and the wall.

- Radiant heat: No direct source of radiant heat

- Power supply: See nameplate
- Socket: Grounded socket

3.2 Installation Steps

- Remove all packing materials.
- Move the device to where it needs to be installed and then fix the castors.
- Install the limit block on the back panel of the device. See Picture 1 (only available for some models).
- Clean the device.
- Wait at least 2 hours, then power and turn on the device.
- If the compressor does not run or the machine shakes violently, please turn off the device and contact us for help.
- If the device works normally and the inner temperature starts dropping, keep it empty and running until it reaches the setting temperature.
- Put in the items, the installation is completed.

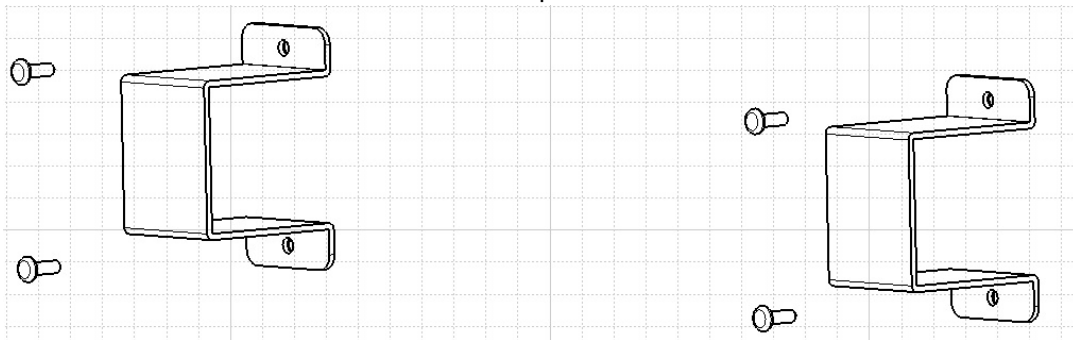

Figure 1

3.3 Application

- Users can adjust the height of the shelf, and the stored items cannot exceed the <Max and Min Loading Line>, to avoid covering the fan outlet, and causing poor refrigeration performance.
- User can adjust the set temperature of the device according to their own needs in the allowed temperature adjustment range. After setting, lock the keyboard to avoid errors caused by incorrect operations.
- Do not store items that are not allowed, see <Safety Instruction>.
- Keep your keys properly.
- It's better to control the door opening time within 1 minute.

4. Operation Instruction

4.1 Structure

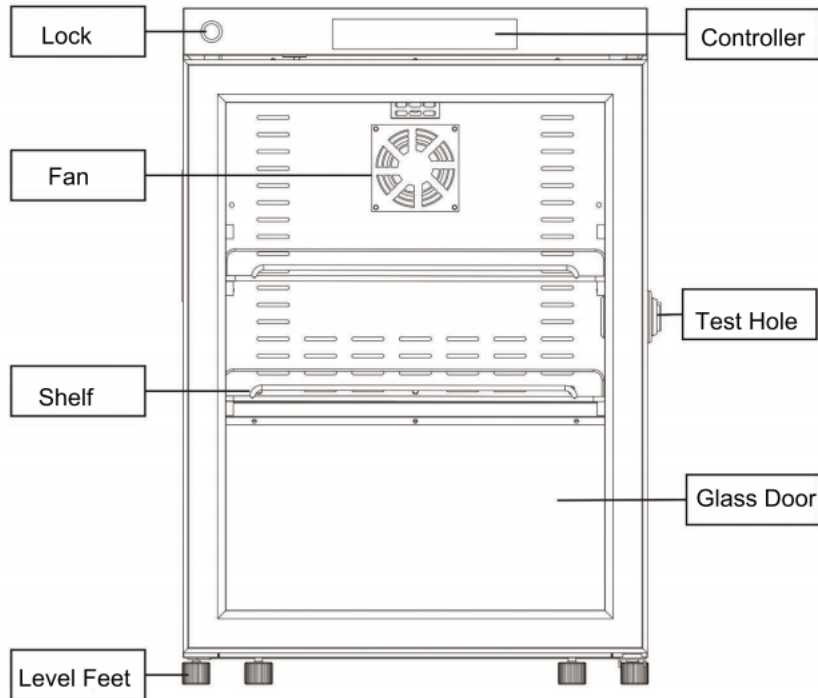

Figure 2

4.2 Temperature Controller

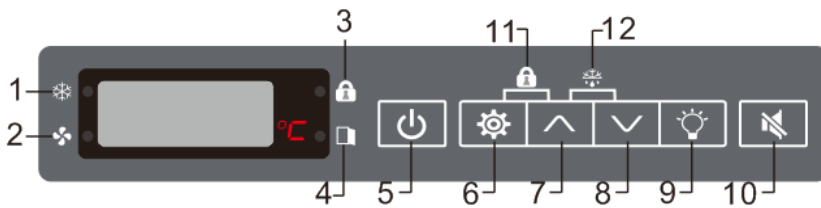

Figure 3

Compressor Running Indicator	Fan Running Indicator
Keyboard Lock Indicator	Door Open Indicator
Power Switch	Set Button
Up Button	Down Button
Light Switch	Mute Button
Keyboard Lock (Combination key)	Defrost (Combination key)

4.3 Adjust Setting Temperature

The device will display the current inner temperature after powering on, please follow the below steps if you need to adjust the setting temperature, for example, change the setting temperature from 5°C to 6°C.











Step	Operation	Display
1		Current inner temperature
2	Press  for 3s	Flickering display current setting temperature 5°C
3	Press 	Value increase
4	Press 	Value decrease
5		Value is 6°C
6	Press  for 3s	Save the operation and back to current inner temp. display

Table 2

4.4 Check Highest and Lowest Temperature

If you want to check the highest and lowest temperatures in the past day, follow the steps below:

Step	Operation	Display
1		Current inner temperature
2	Press 	Display highest temperature during the past day
3	Press 	Display the date when highest temperature happened: HD20 (Day 20)
4	Press 	Display the hour when highest temperature happened: HH09 (9 o'clock)
5	Press 	Display the minute when highest temperature happened: HE30 (30 mins)
6	Press 	Display lowest temperature during the past day
7	Press 	Display the date when lowest temperature happened: LD20 (Day 20)
8	Press 	Display the minute when lowest temperature happened: LH14 (14 o'clock)



9	Press 	Display the seconds when lowest temperature happened: LE25 (25 mins)
10	Press 	Display highest temperature during the past day again

Table 3

NOTE!

- * Press  button for 5 seconds to delete the records.
- * Data record interval is 10 minutes.
- * The record will be deleted at 17:35 every day automatically.

4.5 Set Date and Time

If you want to check the date and time, follow the steps below:













Step	Operation	Display
1		Current inner temperature
2	Press 	Display current year Y_17
3	Press 	Display current month N_03
4	Press 	Display current date D_15
5	Press 	Display current hour H_16
6	Press 	Display current minutes E_20
7	Press 	Display current seconds S_21 (means 16:20:21, Mar. 15 th , 2017)

Table 4

If you want to adjust the date and time, follow the steps below:

Step	Operation	Display
1		Current inner temperature
2	Press  for 5s	Flickering display current year Y_17
3	Press  or 	Adjust the year value
4	Press 	Flickering display current month N_03
5	Press  or 	Adjust the month value
6	Press 	Flickering display current date D_15



7	Press  or 	Adjust the date value
8	...	Adjust the time, minute and second value
9	Press  for 5	Save the adjustment and back to normal display

Table 5

4.6 Alarm

N	Alarm Code	Alarm Description
1	AL	Low temperature alarm
2	AH	High temperature alarm
3	Ado	Door ajar alarm
4	AUF	Power failure alarm
5	AD1S	AD1S Temperature sensor error alarm
6	AD1B	AD1B Temperature sensor error alarm
7	AS1S	AS1S Temperature sensor error alarm
8	AS1B	AS1B Temperature sensor error alarm

Table 6

NOTE!

* When the power fails, the backup battery will power the controller automatically. The controller will flicker and alternate display 'AUF' and current inner temperature.

4.7 Battery Switch

If the device has a backup battery, when power failure, the backup battery will power the control system automatically. Please turn on the battery switch when you start to use this device.

To avoid battery damage due to over-discharge, please turn off the battery switch when stop using the device.

Battery switch location is different for different models. Please check the below pictures.

For some models, if you do not find battery switch, please press ON/OFF button for 5 seconds until the controller stop displaying when stop using the device.

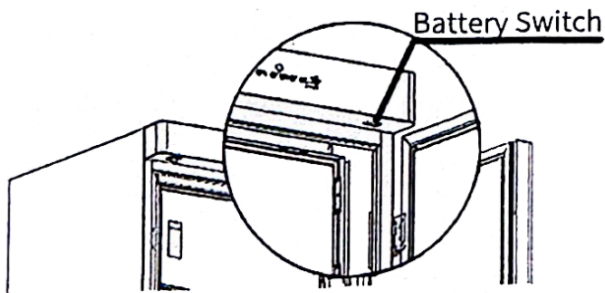

Figure 4
Location 1: Above the external door

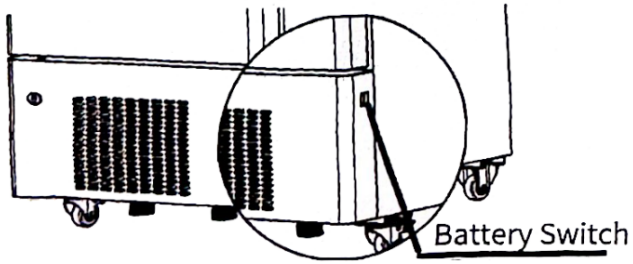

Figure 5
Location 2: On the bottom area of the side panel of the device

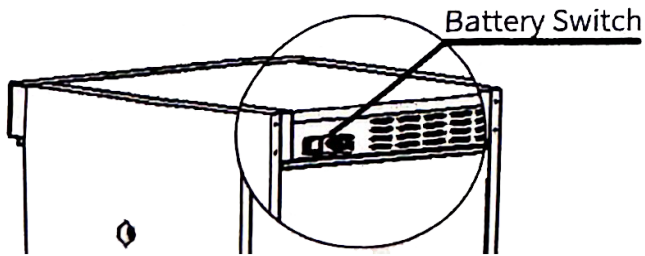

Figure 6
Location 3: On the top area of the back panel

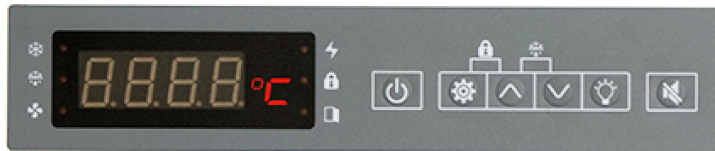

Figure 7
Battery ON/OFF Button
Location 4: On the controller

5. Maintenance

5.1 Before Maintenance

- Inspect and maintain the device at specified intervals.
- Turn off and disconnect the power supply plug before repairing or maintaining the device to prevent electric shock or injuries.
- Wear gloves when maintaining or repairing this device to avoid injury from sharp edges.
- Be careful not to inhale medications or suspended matter in or around the device when maintaining or repairing this device. These may be harmful to your health.

5.2 Clean

- Inspect and clean the device once a month. Regular cleaning will keep your device looking like new.
- Use a dry cloth to wipe dust from the external body, inner chamber and all accessories of the device. If it is very dirty, use neutral detergent when cleaning and clean up the detergent after cleaning.
- Do not pour water onto the device or clean the device with water directly, otherwise, it may cause electric shock or fire.
- If the ambient humidity is very high, the surface of the glass door may have condensation water. Wipe it with a dry cloth. Condensation won't affect refrigeration performance(available for glass door refrigerators).

5.3 Defrost

For refrigerators: It is a forced-air cooling and frost-free refrigerator. No need to defrost during daily use.
For freezers: To keep a stable temperature inside the freezer, the freezer does not have the auto-defrosting function. Please turn off the freezer and clean the ice and frost inside the freezer manually, the recommended defrosting interval is 1~3 months.

5.4 Battery Maintenance

For the device with a battery inside, which should be fully charged. Batteries are consumables. If the battery is low voltage, please replace it in time(available for the device with power failure alarm function).

6. Troubleshooting

Troubles	Reasons and Solutions
The device does not cool down.	<ul style="list-style-type: none"> Is the socket powered? Is the power plug fully inserted in to the socket? Is the fuse or circuit breaker disconnected? Is there a power failure? Is the power switch turned off?
Compressor breaks down	<ul style="list-style-type: none"> Is the setting temperature correct?
Temperature keeps decreasing after reaching the set value	<ul style="list-style-type: none"> Is the setting temperature correct?
Temperature cannot reach the set value	<ul style="list-style-type: none"> Is the cooling fan normal working? Is the door closed well? Is the door been opened and closed frequently? Is there enough space between the stored items for cold air circulation? Is the ambient temperature too high? The available range is 10~32°C. Is there enough space around the device for good ventilation?
Unusual noise	<ul style="list-style-type: none"> Is the device installed on a firm and level floor? Is the device leveled properly? Is the device touched the wall? Is the compressor loose? Is the fan motor abnormal working?

Table 7

Check the above questions, if the trouble remains, contact us or our authorized distributors for help.

7. Circuit Diagram

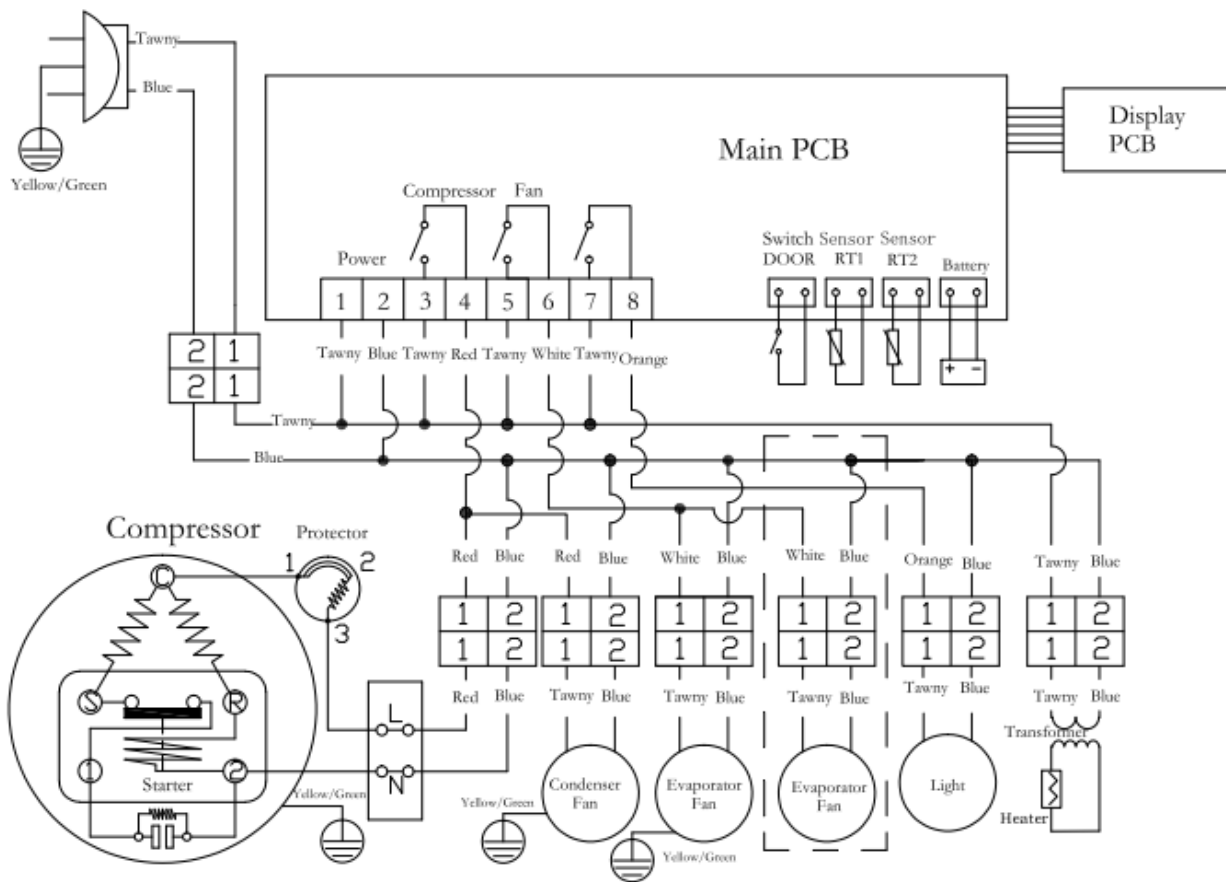

Figure 8

8. Packing List

Model	Manual	Key	Shelf	Shelf Holder	Price Tag	Stop Block	Power Cord
REF13-60	1	2	2	/	2	/	1

LABSTAC

Labstac LLC

82 Wendell Avenue, STE 100, Pittsfield, MA, 01201, USA

Email: contact@labstac.com | Website: labstac.com